

OPTI DD

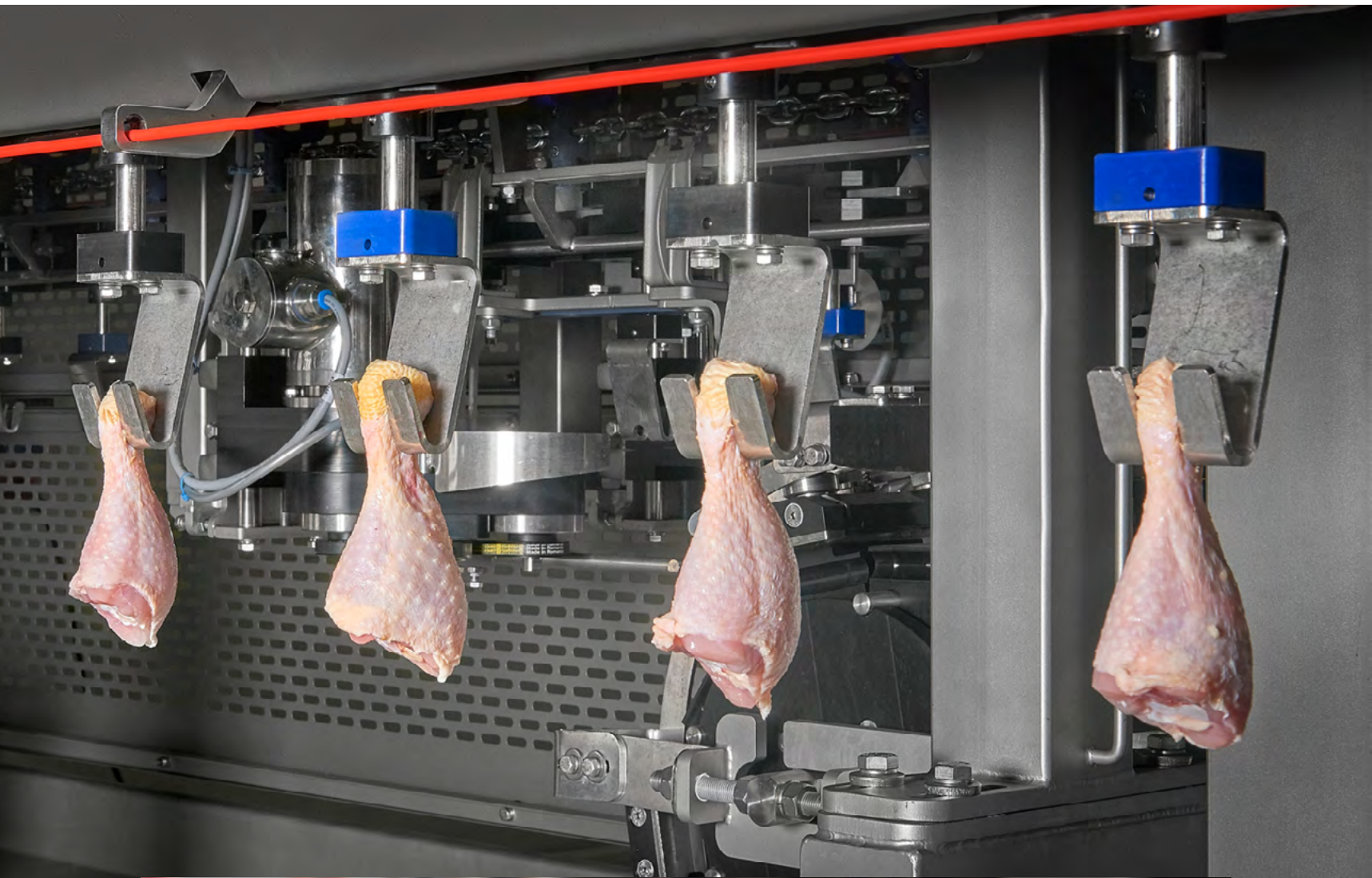

The Efficient Drumstick Deboner

We make it **SIMPLE**

You make it **PROFITABLE**

OPTI DD

THE EFFICIENT DRUMSTICK DEBONER



LOADING AREA

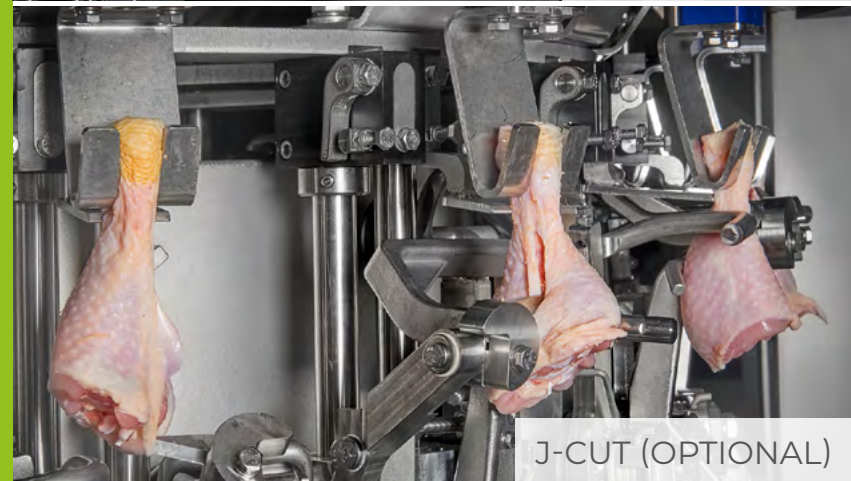

J-CUT (OPTIONAL)



TENDON CUTTER

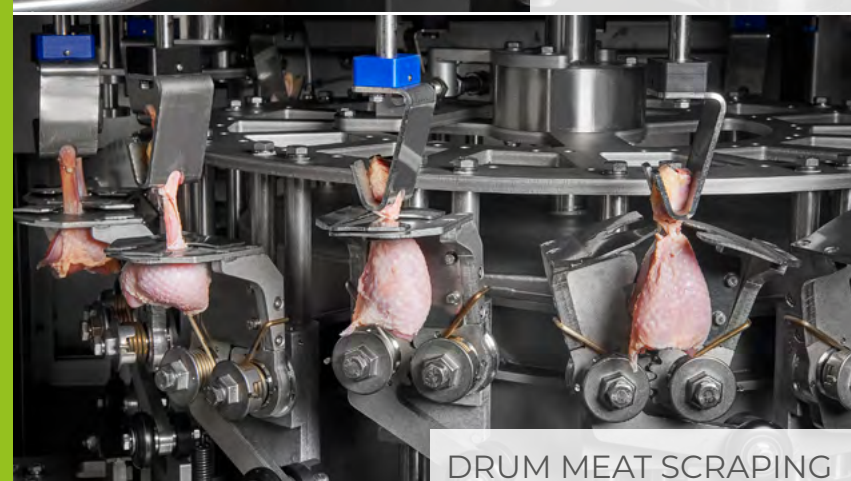

DRUM MEAT SCRAPING



KEY FEATURES

Foodmate developed the OPTI Drumstick Deboner in response to the increasing demand and production of deboned drumstick meat. The machine is designed to run 6000 drumsticks per hour and only requires two loaders due to the Easy Load product shackle.

The OPTI DD debones drumsticks within a large weight range, with or without skin. An excellent end-result in combination with high efficiency.

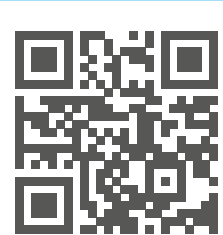

SEE THE
OPTI DD
IN ACTION

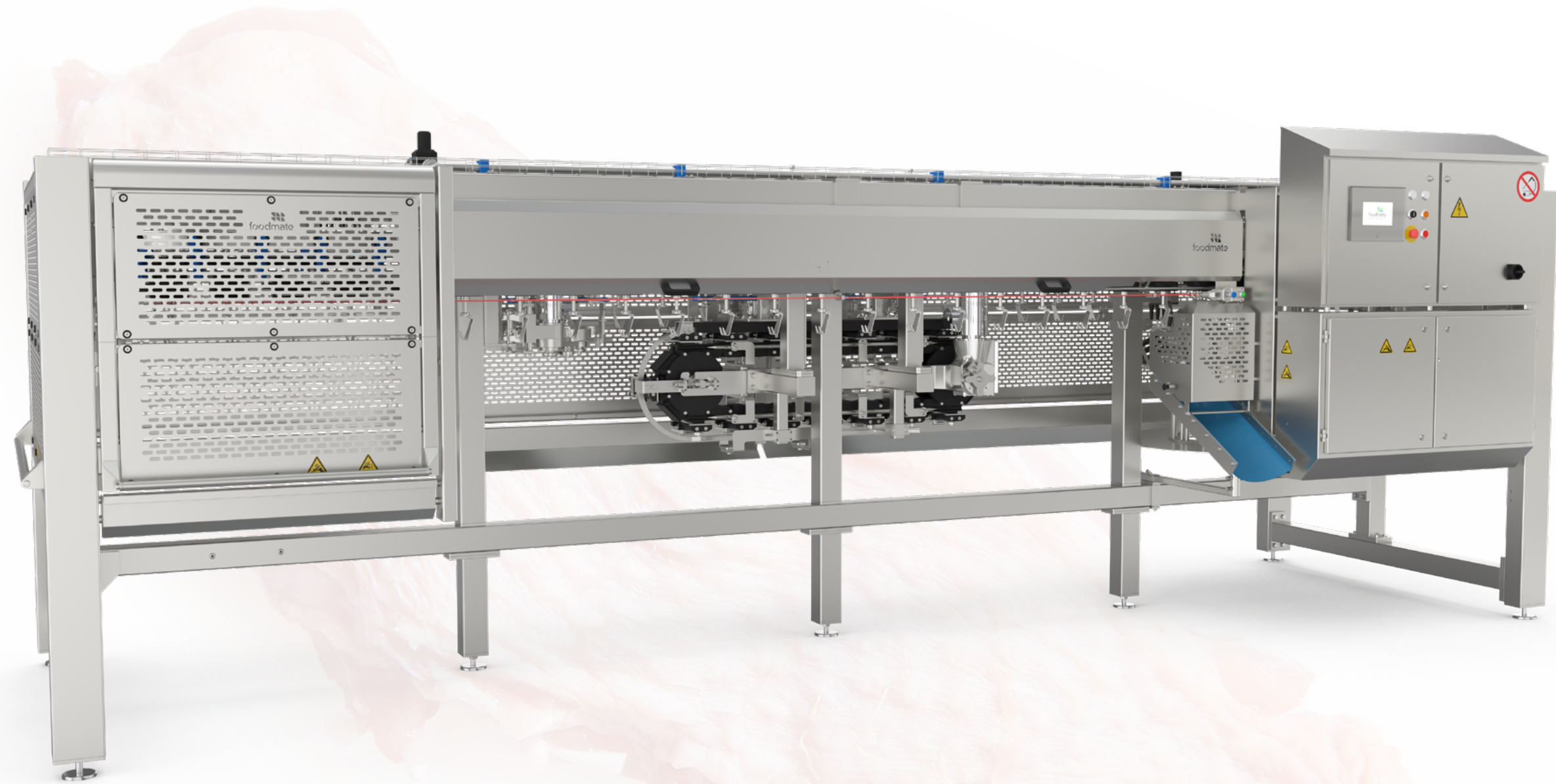

DRUM MEAT HARVESTING

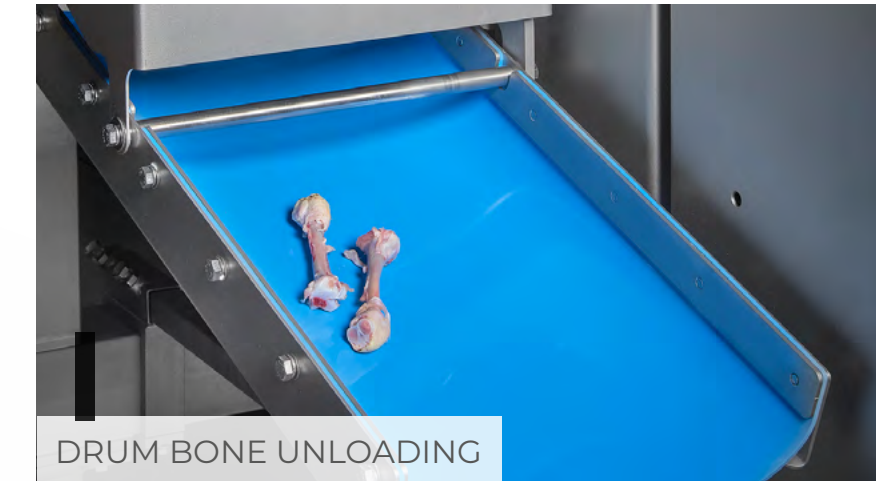

DRUM BONE UNLOADING

Leading Technology in Dark Meat Deboning Solutions

J-CUT

To ensure optimal deboning, the leg must be cut along the drum. A specially designed unit makes a precise cut along the bone without damaging the meat or the bone.

OPTI LTD

Combined with the OPTI TD, the



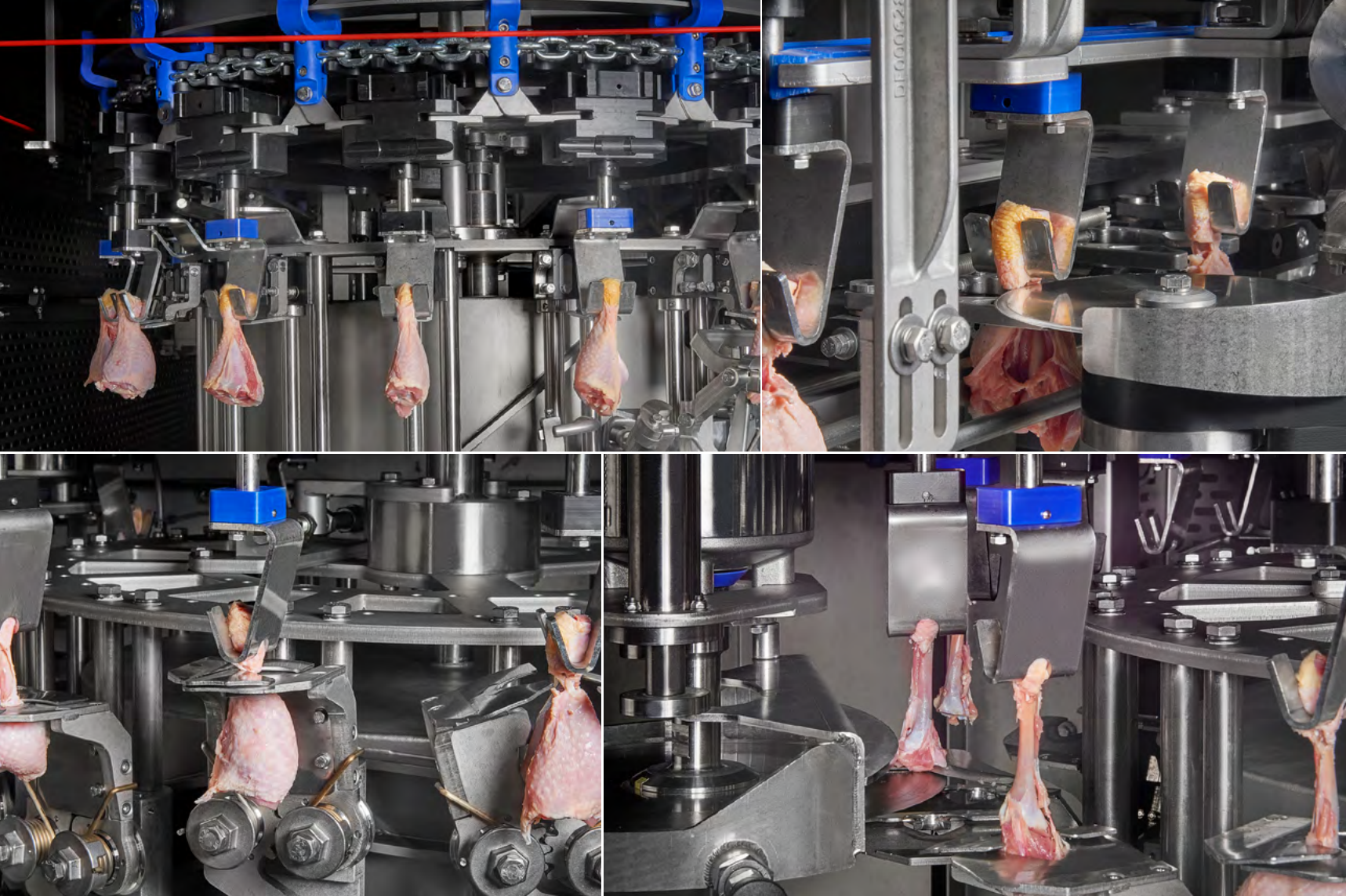

ADVANTAGES

- ✓ Capable of deboning 6000 drums per hour
- ✓ Optional J-Cut unit
- ✓ Drumstick deboning, with or without skin
- ✓ Eliminates bone shattering and fragmenting
- ✓ Excellent yield
- ✓ Machine can process different leg weights
- ✓ Reduces operating and maintenance costs
- ✓ Safety features such as integrated PLCS and DC injection brakes



INITIAL PRODUCT



FINAL PRODUCT



BYPRODUCT

TECHNICAL SPECIFICATIONS

| | |
|-------------------|-----------------|
| Frame and Motor | Stainless steel |
| Power Consumption | 3,5 kW |
| Length | 6230 mm |
| Width | 1800 mm |
| Height | 2145 mm |
| Weight | approx. 2830 kg |

